



IF

IS Belt Drive Type Actuator



IF Series base structure deformation under a given amount of force.



Deformation of competitor's base structure under the same amount of force.

Features:

- Timing belt-type actuator using AC servo motor and incremental optical encoder.
- Maximum stroke length: 2500mm; maximum speed: 1750mm/sec.
- Highly rigid base structure.
- Double slider option increases moment capability and allows greater overhang load length.
- Urethane timing belt is highly durable and generates minimal particles.
- Base structure is highly resistant to torsional deformation and warp.

Specifications:

Type	Motor Capacity (W)	Horizontal Payload (Kg)	Velocity (mm/sec)	Stroke (mm)	Repeatability (mm)	Moment*1 [N • m(Kgf • m)]			
						Slider	Ma	Mb	Mc
S (Small Type)	60	5	1750	200~2000	±0.08	Single	28.4 (2.9)	40.2 (4.1)	65.7 (6.7)
	100	10				Double*2	130.3 (13.3)	185.2 (18.9)	106.8 (10.9)
M (Medium Type)	200	20		200~2500		Single	69.6 (7.1)	99.0 (10.1)	161.7 (16.5)
	400	40				Double*3	316.5 (32.3)	450.8 (46.0)	262.0 (26.8)

*1: When the moment is a dynamic rated moment load.
 *2: For the double slider, when the distance between the two sliders is 45mm.
 *3: For the double slider, when the distance between the two sliders is 55mm.

Model Type:

IF-SA-60-600-2R-L-T1-ABN

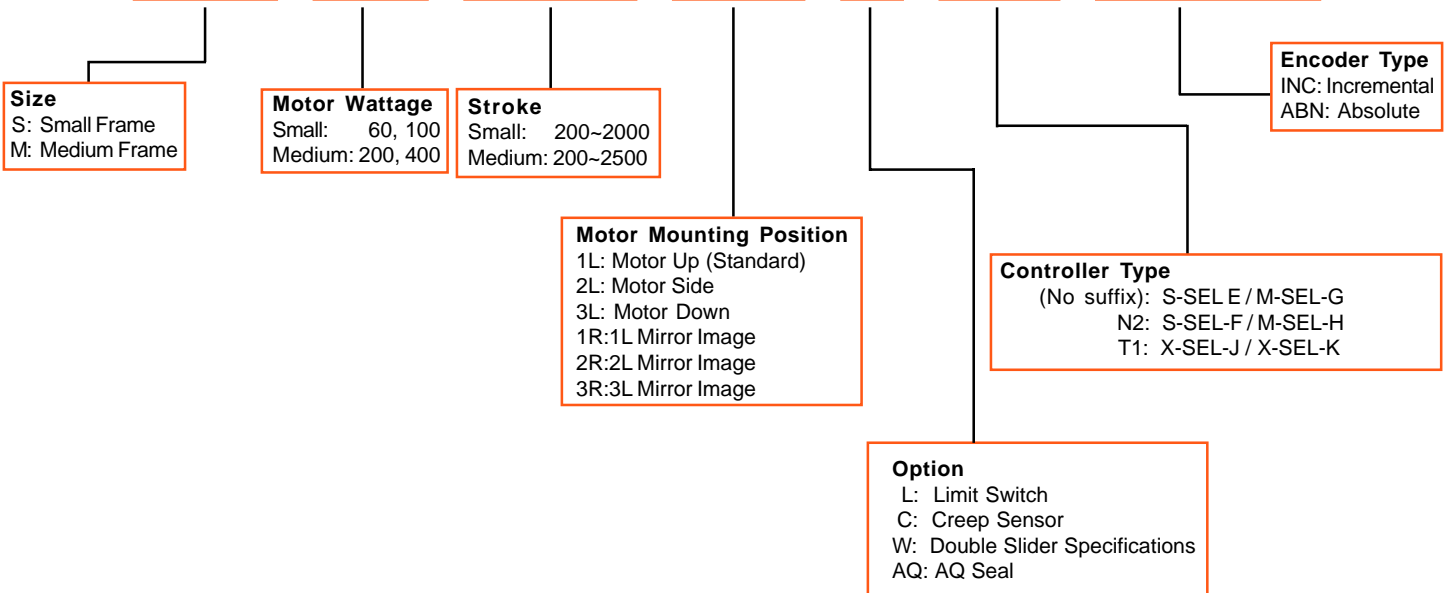

Optional Motor Positions:

- There are total of 6 positions to choose from regarding the position of the motor on the IF Series actuator. The 1L, 2L and 3L positions are shown below. The other 3 options are the mirror images of the 1L, 2L and 3L positions and are designated as 1R:1L, 2R:2L, and 3R:3R, respectively.

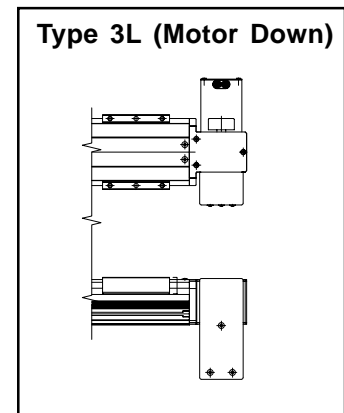
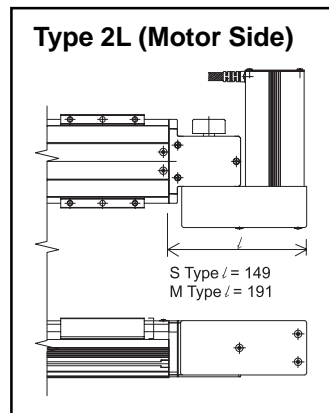
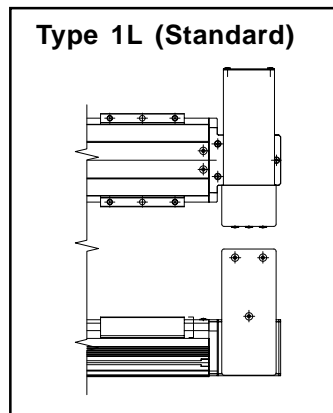

Note: The above 3 diagrams shown are for medium type actuators. Please be aware that for the small type actuators, the motor size varies according to wattage. Therefore, the motor arrangement will vary.

IF-SA-60 [Small 60W Type]

Stroke	mm	200	300	400	500	600	700	800	900	1000	1100	1200	1300	1400	1500	1600	1700	1800	1900	2000
Rated Output	W	60																		
Maximum Speed	mm/sec	1750																		
Repeatability	mm	± 0.08																		
Unit Weight	kg	4.4	4.9	5.4	5.9	6.4	6.8	7.3	7.8	8.3	8.8	9.2	9.7	10.2	10.7	11.2	11.6	12.1	12.6	13.1
Motor		AC Servo Motor																		
Encoder		Absolute/Incremental																		
Feed Structure		Timing Belt backlash under 0.1mm																		
Guide		IF Exclusive Single Unit																		
Motor, Belt Connector		Deceleration through timing belt																		
Base, Slider		Exclusive extruded aluminum (A6NO1S-T5 equivalent) White alumite treatment																		
Slider Payload Weight (*1, *2)	kgw	Horizontal use: 5																		
Load Moment (*1, *3)	N • m (kgf • m)	Single Slider	Ma: 28.4 (2.9) Mb: 40.2 (4.1) Mc: 65.7 (6.7)																	
		Double Slider (with span of 45mm)	Ma: 130.3 (13.3) Mb:185.2 (18.9) Mc: 106.8 (10.9)																	
		Double Slider (with span of 60mm)	Ma: 142.0 (14.5) Mb: 203.8 (20.8) Mc:106.8 (10.9)																	
Overhang Load Length L (*4)	mm	Single Slider	Ma direction: Under 450 Mb, Mc direction: Under 450																	
		Double Slider (with span of 45mm)	Ma direction: Under 1125 Mb, Mc direction: Under 1125																	
		Double Slider (with span of 60mm)	Ma direction: Under 1200 Mb, Mc direction: Under 1200																	

- *1: Even load distribution on the slider.
Fix base securely to a flat, strong frame.
- *2: At an acceleration of 0.3G and a speed of 1750mm/sec.
- *3: In case the running span is 10,000km.
Direction of load moment is shown on the right diagram.
- *4: When the center of gravity for the attached object is 1/2 of the overhang length.

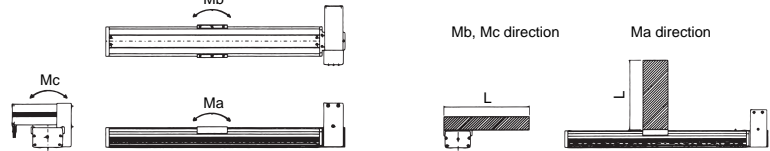

Dimensions

Single Slider

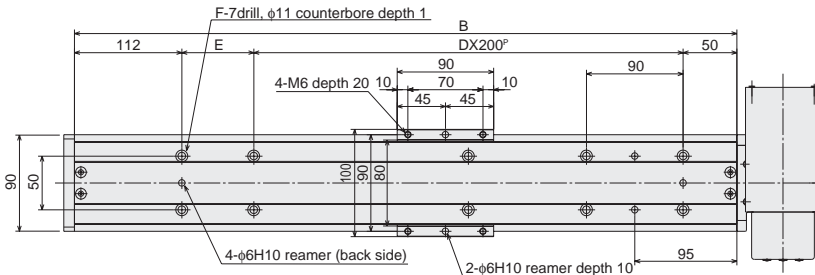

* During homing, since the slider will move up to M.E., please be cautious of interferences with surrounding objects.

M.E.: Mechanical End
S.E.: Stroke End

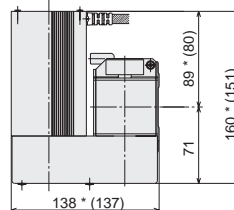

* () indicates the dimensions for the N2, T1 specifications.

Double Slider

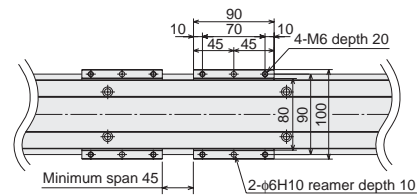
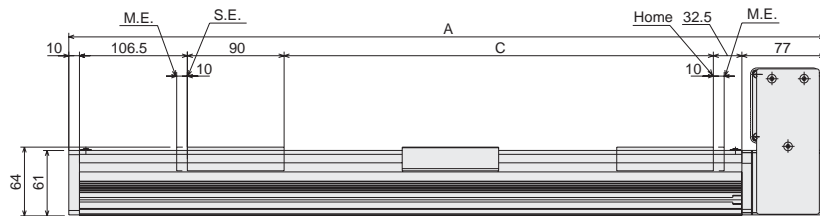

* For the double slider, the stroke span is shorter due to the slider length + slider

Stroke	200	300	400	500	600	700	800	900	1000	1100	1200	1300	1400	1500	1600	1700	1800	1900	2000
A	516	616	716	816	916	1016	1116	1216	1316	1416	1516	1616	1716	1816	1916	2016	2116	2216	2316
B	429	529	629	729	829	929	1029	1129	1229	1329	1429	1529	1629	1729	1829	1929	2029	2129	2229
C	200	300	400	500	600	700	800	900	1000	1100	1200	1300	1400	1500	1600	1700	1800	1900	2000
D	1	1	2	2	3	3	4	4	5	5	6	6	7	7	8	8	9	9	10
E	67	167	67	167	67	167	67	167	67	167	67	167	67	167	67	167	67	167	67
F	8	8	10	10	12	12	14	14	16	16	18	18	20	20	22	22	24	24	26

IF-SA-100 [Small 100W Type]

Stroke	mm	200	300	400	500	600	700	800	900	1000	1100	1200	1300	1400	1500	1600	1700	1800	1900	2000
Rated Output	W	100																		
Maximum Speed	mm/sec	1750																		
Repeatability	mm	± 0.08																		
Unit Weight	kg	4.6	5.1	5.6	6.1	6.6	7.0	7.5	8.0	8.5	9.0	9.4	9.9	10.4	10.9	11.4	11.8	12.3	12.8	13.3
Motor		AC Servo Motor																		
Encoder		Absolute/Incremental																		
Feed Structure		Timing Belt backlash under 0.1mm																		
Guide		IF Exclusive Single Unit																		
Motor, Belt Connector		Deceleration through timing belt																		
Base, Slider		Exclusive extruded aluminum (A6N01S-T5 equivalent) White alumite treatment																		
Slider Payload Weight (*1, *2)	kgw	Horizontal use: 10																		
Load Moment (*1, *3)	N • m (kgf • m)	Single Slider	Ma: 28.4 (2.9)			Mb: 40.2 (4.1)			Mc: 65.7 (6.7)											
		Double Slider (with span of 45mm)	Ma: 130.3 (13.3)			Mb: 185.2 (18.9)			Mc: 106.8 (10.9)											
		Double Slider (with span of 60mm)	Ma: 142.0 (14.5)			Mb: 203.8 (20.8)			Mc: 106.8 (10.9)											
Overhang Load Length L (*4)	mm	Single Slider	Ma direction: Under 450			Mb, Mc direction: Under 450														
		Double Slider (with span of 45mm)	Ma direction: Under 1125			Mb, Mc direction: Under 1125														
		Double Slider (with span of 60mm)	Ma direction: Under 1200			Mb, Mc direction: Under 1200														

- *1: Even load distribution on the slider.
Fix base securely to a flat, strong frame.
- *2: At an acceleration of 0.3G and a speed of 1750mm/sec.
- *3: In case the running span is 10,000km.
Direction of load moment is shown on the right diagram.
- *4: When the center of gravity for the attached object is 1/2 of the overhang length.

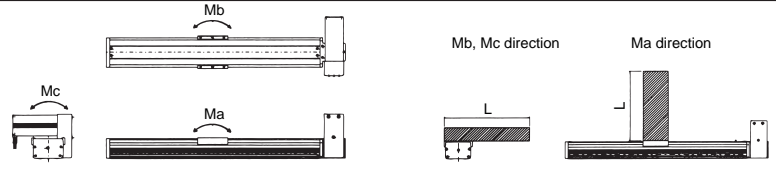

Dimensions

Single Slider

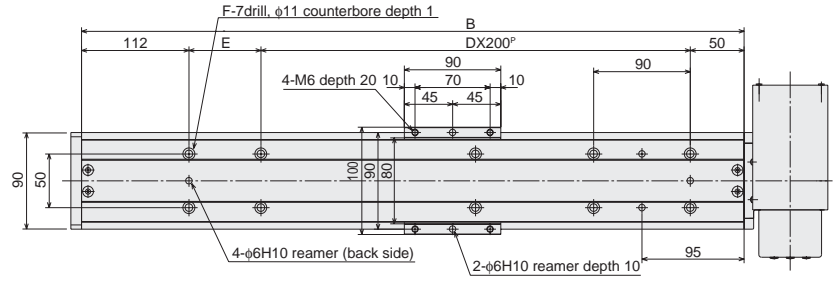

* During homing, since the slider will move up to M.E., please be cautious of interferences with surrounding objects.

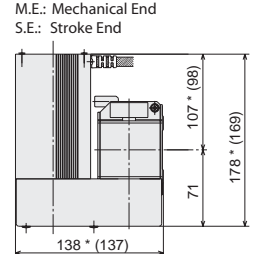

* () indicates the dimensions for N2, T1 specifications.

Double Slider

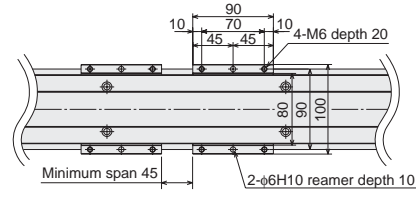
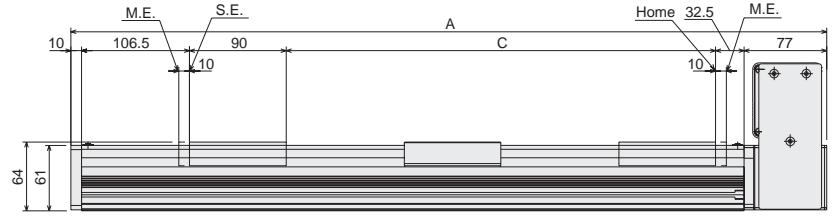

* For the double slider, the stroke span is shorter due to the slider length + slider.

Stroke	200	300	400	500	600	700	800	900	1000	1100	1200	1300	1400	1500	1600	1700	1800	1900	2000
A	516	616	716	816	916	1016	1116	1216	1316	1416	1516	1616	1716	1816	1916	2016	2116	2216	2316
B	429	529	629	729	829	929	1029	1129	1229	1329	1429	1529	1629	1729	1829	1929	2029	2129	2229
C	200	300	400	500	600	700	800	900	1000	1100	1200	1300	1400	1500	1600	1700	1800	1900	2000
D	1	1	2	2	3	3	4	4	5	5	6	6	7	7	8	8	9	9	10
E	67	167	67	167	67	167	67	167	67	167	67	167	67	167	67	167	67	167	67
F	8	8	10	10	12	12	14	14	16	16	18	18	20	20	22	22	24	24	26

IF-MA-200 [Medium 200W Type]

Stroke	mm	200	300	400	500	1000	1100	1200	1300	1400	1500	1600	1700	1800	1900	2000	2100	2200	2300	2400	2500	
Rated Output	W	200																				
Maximum Speed	mm/sec	1750																				
Repeatability	mm	± 0.08																				
Unit Weight	kg	7.7	8.5	9.3	10.0	14.0	14.8	15.6	16.4	17.2	17.9	18.7	19.5	20.3	21.1	21.9	22.7	23.5	24.3	25.1	25.8	
Motor		AC Servo Motor																				
Encoder		Single Unit with the motor																				
Feed Structure		Timing Belt backlash under 0.1mm																				
Guide		IF Exclusive Single Unit																				
Motor, Belt Connector		Deceleration through timing belt																				
Base, Slider		Exclusive extruded aluminum (A6N01S-T5 equivalent) White alumite treatment																				
Slider Payload Weight (*1, *2)	kgw	Horizontal use: 20																				
Load Moment (*1, *3)	N • m (kgf • m)	Single Slider	Ma: 69.6 (7.1)										Mb: 99.0 (10.1) Mc: 161.7 (16.5)									
		Double Slider (with span of 55mm)	Ma: 316.5 (32.3)										Mb: 450.8 (46.0) Mc: 262.0 (26.8)									
		Double Slider (with span of 80mm)	Ma: 350.0 (35.8)										Mb: 500.0 (51.0) Mc: 262.0 (26.8)									
Overhang Load Length L (*4)	mm	Single Slider	Ma direction: Under 600										Mb, Mc direction: Under 600									
		Double Slider (with span of 55mm)	Ma direction: Under 1475										Mb, Mc direction: Under 1475									
		Double Slider (with span of 80mm)	Ma direction: Under 1600										Mb, Mc direction: Under 1600									

- *1: Even load distribution on the slider.
Fix base securely to a flat, strong frame.
- *2: At an acceleration of 0.3G and a speed of 1750mm/sec.
- *3: In case the running span is 10,000km.
Direction of load moment is shown on the right diagram.
- *4: When the center of gravity for the attached object is 1/2 of the overhang length.

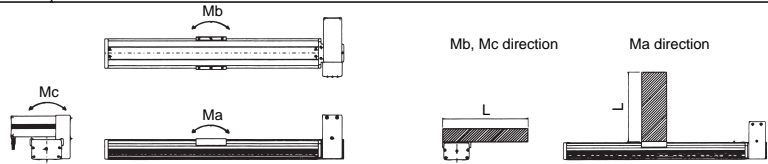

Dimensions

Single Slider

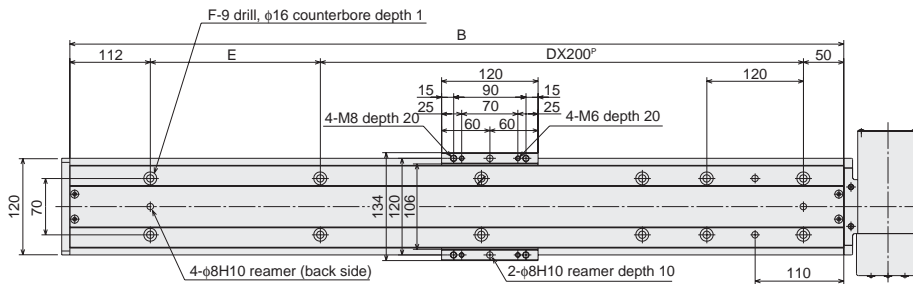

* During homing, since the slider will move up to M.E., please be cautious of interferences with surrounding objects.

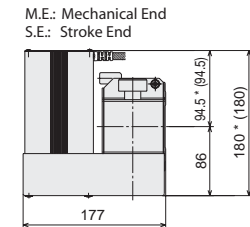

* () indicates the dimensions for N2, T1 specifications.

Double Slider

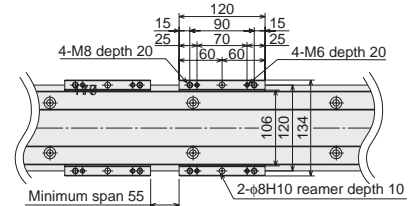
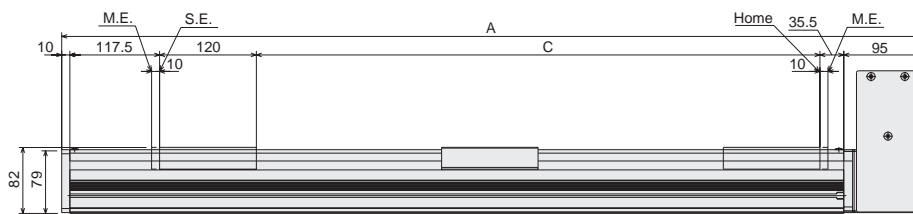

* For the double slider, the stroke span is shorter due to the slider length + slider.

Stroke	200	300	400	500	600	700	800	900	1000	1100	1200	1300	1400	1500	1600	1700	1800	1900	2000	2100	2200	2300	2400	2500
A	578	678	778	878	978	1078	1178	1278	1378	1478	1578	1678	1778	1878	1978	2078	2178	2278	2378	2478	2578	2678	2778	2878
B	473	573	673	773	873	973	1073	1173	1273	1373	1473	1573	1673	1773	1873	1973	2073	2173	2273	2373	2473	2573	2673	2773
C	200	300	400	500	600	700	800	900	1000	1100	1200	1300	1400	1500	1600	1700	1800	1900	2000	2100	2200	2300	2400	2500
D	1	1	2	2	3	3	4	4	5	5	6	6	7	7	8	8	9	9	10	10	11	11	12	12
E	111	211	111	211	111	211	111	211	111	211	111	211	111	211	111	211	111	211	111	211	111	211	111	211
F	8	8	10	10	12	12	14	14	16	16	18	18	20	20	22	22	24	24	26	26	28	28	30	30

Option:

• Double Slider:

The double slider option provides the added feature and ability to vary the distance between the two sliders. One slider is mounted to the timing belt and linear guide, while the other is mounted *only* to the linear motion guide. The double Slider option increases the overhang load capability of the IF Series actuator and adds a new dimension of flexibility to accommodate a wide variety of configurations.

Utilizing the double slider specifications:

Please make sure that the overhang load is maintained within a $L1/L2 \leq 5$ relationship (see diagram below). By increasing the distance between the sliders, the M_a and M_b moment and overhang load capability can be increased.

Note: Because the slider is added to the standard stroke length, the effective stroke of the actuator will be decreased by the distance between the sliders plus the width of the slider.

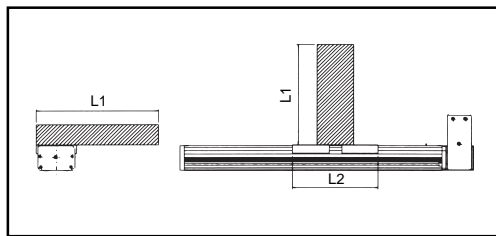

- **Limit Switch:** This option is used to detect the location of the home position (see diagram below for mounting location).
- **Creep Sensor:** This option is used when high-speed homing is desired (see diagram below for mounting location).
- **Double Slider:** This option is used when the overhang load length and/or moment exceeds the specifications of the standard single-slider version actuator.
- **AQ Seal:** Use this option to reduce troublesome greasing work to a minimal frequency (long term maintenance free operation of 5000km or 3 years between application of grease).

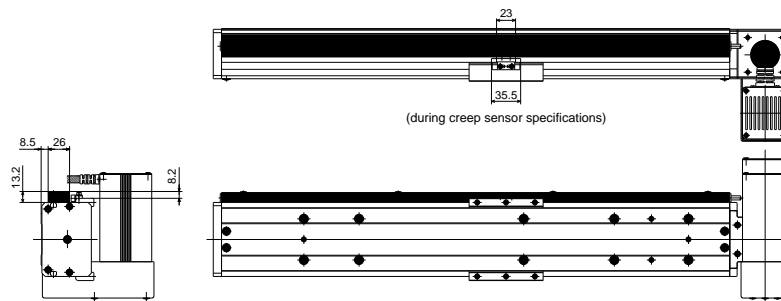

Note:1 With the E/G Type controller, you can only have one limit sensor (limit switch or creep sensor).

Note:2 The actuator dimensions vary according to the desired option. Please contact your IAI representative for details.



www.intelligentactuator.com

U.S. Sales Offices

(U.S. Headquarters)
2690 West 237th Street
Torrance, CA 90505
(800) 736-1712 (310) 891-0815 FAX

(Illinois Regional Office)
1261 Hamilton Parkway
Itasca, IL 60143
(800) 944-0333 (630) 467-9912 FAX

(Eastern Regional Office)
7 South Main Street, Suite F
Marlboro, NJ 07746
(732) 683-9101 (732) 683-9103 FAX